











33 526 660



- Ausladung 125 mm
- starrer Auslauf
- runder luftangereicherter Strahl
- Armaturenhöhe 133 mm
- Höhe bis Luftsprudler 52 mm
- Bohrungsdurchmesser 35 mm
- 2x Druckschlauch M 8 x 1 eingeschraubt, dichtheitsgeprüft
- Durchfluss max. 5,7 l/min
- bleifrei
- Dieses Produkt leistet einen Beitrag zur Erfüllung der Vorgaben von nachhaltigen Gebäudezertifizierungen, z.B. LEED®, BREEAM®, DGNB

	Champagne (22kt Gold)	33 526 660-47
	Chrom	33 526 660-00
	Platin gebürstet	33 526 660-06
	Dark Chrome	33 526 660-19
	Light Gold	33 526 660-26
	Light Gold gebürstet	33 526 660-27
	Schwarz matt	33 526 660-33
	Bronze gebürstet	33 526 660-42
	Champagne gebürstet (22kt Gold)	33 526 660-46
	Chrom gebürstet	33 526 660-93
	Dark Platin gebürstet	33 526 660-99

33 526 660

mm [inches]

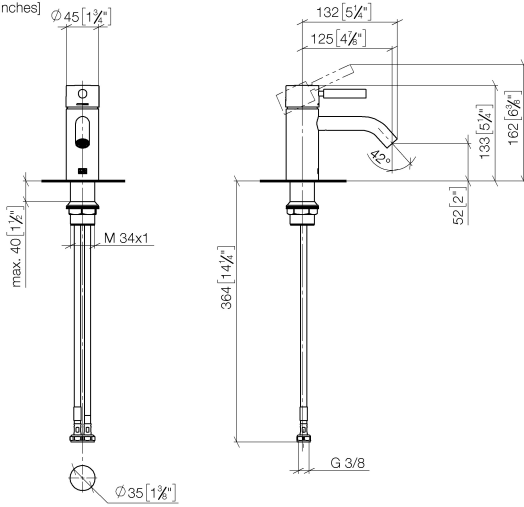

Durchflussdiagramm



33 526 660
Ersatzteile für die
anderen
Oberflächenvarianten
finden Sie hier:
Chrom

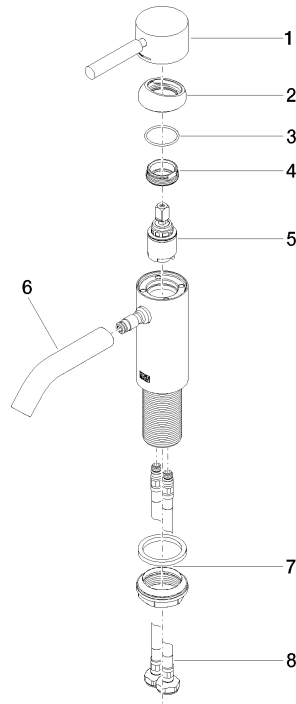

Ersatzteilstückliste

Nr.	Artikelnummer	Benennung	Verbaumenge	Lieferzeit
1	90 20 66 002 00-47	Griff	1	30
2	09 28 30 041-47	Haube	1	60
3	09 14 10 091 90	Dichtung	1	2
4	09 24 04 266 90	Mutter	1	2
5	90 15 05 044 00 90	Kartusche	1	2
6	90 11 06 206 00-47	Auslauf	1	30
7	04 23 10 044 07 90	Befestigungssatz	1	2
8	04 30 04 100 00 90	Schlauch	2	2